



GCSE COMPUTER SCIENCE 8520/2

Paper 2 Written Assessment

Mark scheme

June 2019

Version: 1.0 Final

Mark schemes are prepared by the Lead Assessment Writer and considered, together with the relevant questions, by a panel of subject teachers. This mark scheme includes any amendments made at the standardisation events which all associates participate in and is the scheme which was used by them in this examination. The standardisation process ensures that the mark scheme covers the students' responses to questions and that every associate understands and applies it in the same correct way. As preparation for standardisation each associate analyses a number of students' scripts. Alternative answers not already covered by the mark scheme are discussed and legislated for. If, after the standardisation process, associates encounter unusual answers which have not been raised they are required to refer these to the Lead Examiner.

It must be stressed that a mark scheme is a working document, in many cases further developed and expanded on the basis of students' reactions to a particular paper. Assumptions about future mark schemes on the basis of one year's document should be avoided; whilst the guiding principles of assessment remain constant, details will change, depending on the content of a particular examination paper.

Further copies of this mark scheme are available from aqa.org.uk

The following annotation is used in the mark scheme:

- ;** - means a single mark
- //** - means alternative response
- /** - means an alternative word or sub-phrase
- A** - means acceptable creditworthy answer. Also used to denote a valid answer that goes beyond the expectations of the GCSE syllabus.
- R** - means reject answer as not creditworthy
- NE** - means not enough
- I** - means ignore
- DPT** - in some questions a specific error made by a candidate, if repeated, could result in the candidate failing to gain more than one mark. The DPT label indicates that this mistake should only result in a candidate losing one mark on the first occasion that the error is made. Provided that the answer remains understandable, subsequent marks should be awarded as if the error was not being repeated.

Copyright information

For confidentiality purposes acknowledgements of third-party copyright material are published in a separate booklet which is available for free download from www.aqa.org.uk after the live examination series.

Copyright © 2019 AQA and its licensors. All rights reserved.

Level of response marking instructions

Level of response mark schemes are broken down into levels, each of which has a descriptor. The descriptor for the level shows the average performance for the level. There are marks in each level.

Before you apply the mark scheme to a student's answer read through the answer and annotate it (as instructed) to show the qualities that are being looked for. You can then apply the mark scheme.

Step 1 Determine a level

Start at the lowest level of the mark scheme and use it as a ladder to see whether the answer meets the descriptor for that level. The descriptor for the level indicates the different qualities that might be seen in the student's answer for that level. If it meets the lowest level then go to the next one and decide if it meets this level, and so on, until you have a match between the level descriptor and the answer. With practice and familiarity you will find that for better answers you will be able to quickly skip through the lower levels of the mark scheme.

When assigning a level you should look at the overall quality of the answer and not look to pick holes in small and specific parts of the answer where the student has not performed quite as well as the rest. If the answer covers different aspects of different levels of the mark scheme you should use a best fit approach for defining the level and then use the variability of the response to help decide the mark within the level, ie if the response is predominantly level 3 with a small amount of level 4 material it would be placed in level 3 but be awarded a mark near the top of the level because of the level 4 content.

Step 2 Determine a mark

Once you have assigned a level you need to decide on the mark. The descriptors on how to allocate marks can help with this. The exemplar materials used during standardisation will help. There will be an answer in the standardising materials which will correspond with each level of the mark scheme. This answer will have been awarded a mark by the Lead Examiner. You can compare the student's answer with the example to determine if it is the same standard, better or worse than the example. You can then use this to allocate a mark for the answer based on the Lead Examiner's mark on the example.

You may well need to read back through the answer as you apply the mark scheme to clarify points and assure yourself that the level and the mark are appropriate.

Indicative content in the mark scheme is provided as a guide for examiners. It is not intended to be exhaustive and you must credit other valid points. Students do not have to cover all of the points mentioned in the Indicative content to reach the highest level of the mark scheme.

An answer which contains nothing of relevance to the question must be awarded no marks.

Qu	Part	Marking guidance	Total marks
01	1	<p>1 mark for AO2 (apply)</p> <p>1100 0101;</p>	1
01	2	<p>2 marks for AO2 (apply)</p> <p>164;;</p> <p>If incorrect answer is given then maximum of 1 mark for working.</p> <ul style="list-style-type: none"> determining that A is worth 10 irrespective of it being in the correct column (place value); multiplying an incorrect conversion of A by 16; converting to binary to give 1010 0100; 	2
02	1	<p>1 mark for AO2 (apply)</p> <p>$31 // 2^5 - 1$;</p>	1
02	2	<p>2 marks for AO2 (apply)</p> <p>24 000 000;;</p> <p>If incorrect answer is given then maximum of 1 mark for working.</p> <ul style="list-style-type: none"> $3\ 000\ 000 // 3 * 1000 * 1000$ to calculate the correct number of bytes; Multiplying an incorrect number of bytes by 8; $3\ 000\ 000 * 8$ with incorrect result; 	2
03		<p>1 mark for AO1 (understanding)</p> <ul style="list-style-type: none"> To be able to represent additional/more characters/more languages (and symbols not available in the ASCII character set); ASCII only allows 128 characters whereas Unicode can represent more; To represent characters from other alphabets; <p>A. a response that says a specific single character can be shown ie “a playing card character can be shown”;</p> <p>A. to represent non-English languages;</p>	1

04	<p>2 marks for AO1 (recall)</p> <p>A Arithmetic logic unit; B Control unit;</p> <p>If more than two lozenges shaded then marks are not awarded.</p>	2
----	--	---

05	<p>2 marks for AO1 (recall)</p> <p>Max of two marks.</p> <ul style="list-style-type: none"> • Word processor; • Spreadsheet; • Presentation; • Web browser; • Graphic design//CAD//Computer Aided Design; • Database//RDMS//Relational Database Management System; • Media player//Video player//Music player; • Music creator; • Bespoke software//Custom designed software; <p>A. any other appropriate answer that is not a software brand.</p> <p>R. Microsoft Word, Corel Draw, Internet Explorer, Chrome as they are brands. R. Utility software such as virus scanner, disk maintenance tools etc. R. Games as it was the given example.</p> <p>The addition of “software” to the answers is optional.</p>	2
----	--	---

06	<p>1 mark for AO1 (recall)</p> <p>B Secondary storage is non-volatile;</p> <p>If more than one lozenge shaded then mark is not awarded.</p>	1
----	--	---

07		<p>4 marks for AO1 (understanding)</p> <p>Max of four marks.</p> <ul style="list-style-type: none"> • Disk rotates (at high speed); • Laser head moves across (radius of) disk; • Laser shines onto the disk; • Tiny indentations/pits/bumps reflect light differently (to lands/flats)//Different colour of dye reflects or blocks laser light; • Reflected light is interpreted into 1s and 0s representing data stored on disk; • Data is stored on a single spiral track (rather than concentric tracks); <p>R. Reference to pits and lands corresponding to ones and zeros unless combined with a description of how they reflect light.</p>	4
----	--	---	---

08	1	<p>1 mark for AO2 (apply)</p> <p>LEAST;</p> <p>A. Any text sentence such as ‘the string represents the word LEAST’;</p> <p>I. upper/lower case.</p>	1
----	---	--	---



08	2	<p>2 marks for AO2 (apply)</p> <table border="1" data-bbox="264 1227 699 1379"> <tr> <td>S</td> <td>T</td> <td>A</td> <td>R</td> </tr> <tr> <td>1010</td> <td>1011</td> <td>00</td> <td>01</td> </tr> </table> <p>1010 1011 00 01;;</p> <p>2 marks for all four codes correct ;; 1 mark for any two codes correct ;</p> <p>A. Clearly written codes that are correct as shown above, even if they are not written in the table.</p>	S	T	A	R	1010	1011	00	01	2
S	T	A	R								
1010	1011	00	01								

09	<p>4 marks for AO2 (apply)</p> <p>1 mark for stating each reason to a maximum of 2. Maximum 1 mark for justifying/explaining each reason to a maximum of 2.</p> <ul style="list-style-type: none"> • Algorithms cannot be copyrighted; and therefore need to be protected to preserve commercial advantage; • Copyright of code; the company has paid for development of the code and therefore own the code. They may not want others to have access to what they have developed; • Hacking/cyber security; hackers could identify vulnerabilities in the source code and use them to create targeted attacks; • So third parties cannot insert/modify code and pass it off as original; as it affects profitability; <p>R. Cracking.</p>	4
----	--	---

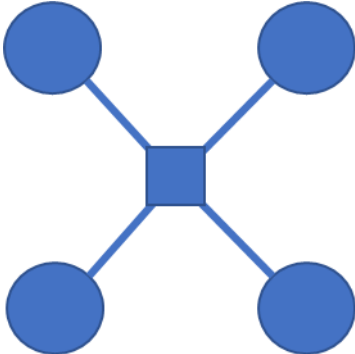
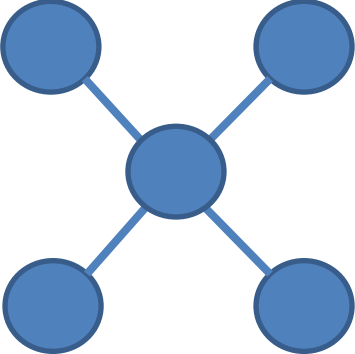
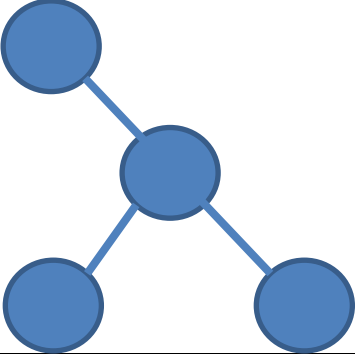
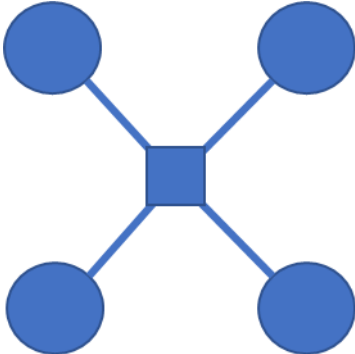
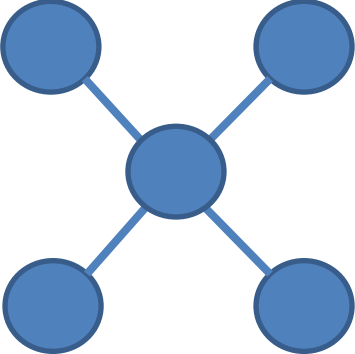
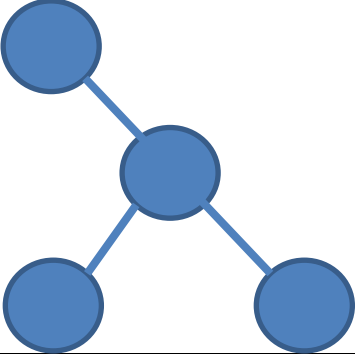
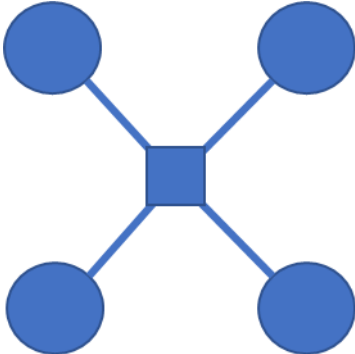
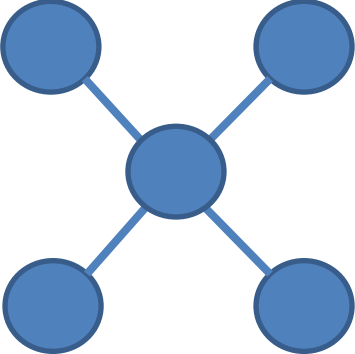
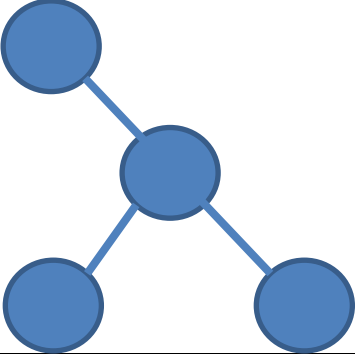
10	<p>2 marks for AO1 (recall)</p> <p>A computer system:</p> <ul style="list-style-type: none"> • with a dedicated/specific purpose or function; • built in to a physical product/device/machine; <p>A. a (computer) system with firmware/software inside a product/device; A. reference to 'system' if relevant examples are given for clarification;</p> <p>NE. a specific example eg. "like in a washing machine" without further qualification.</p>	2
----	--	---

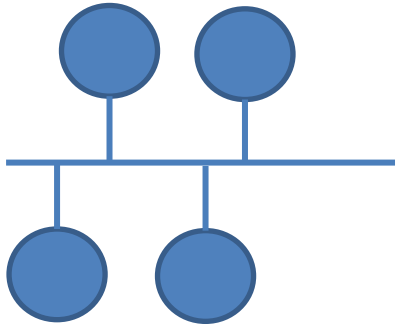
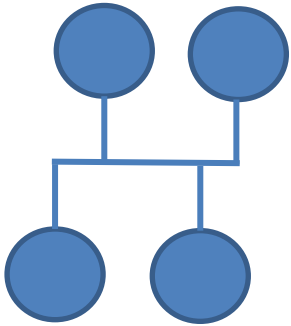
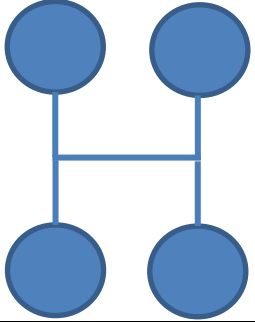
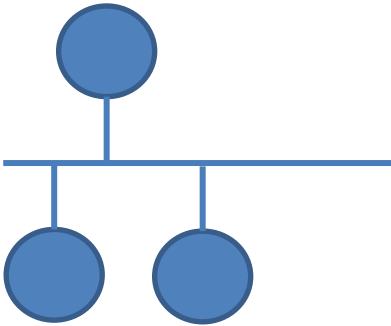
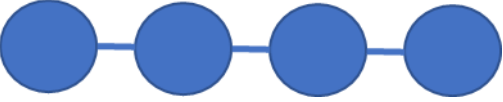
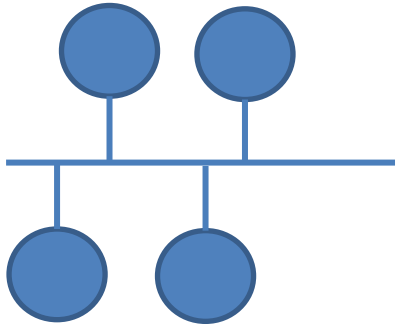
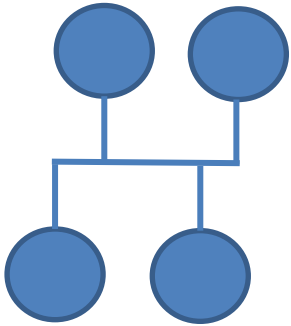
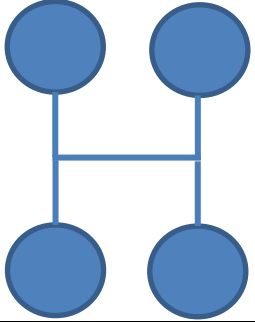
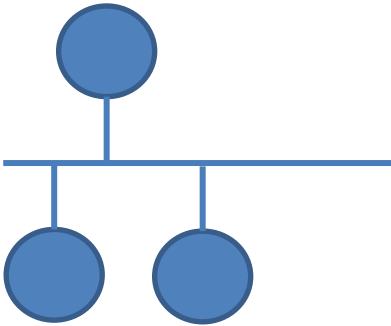
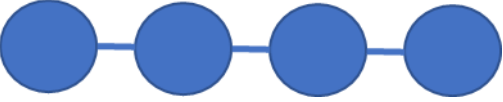
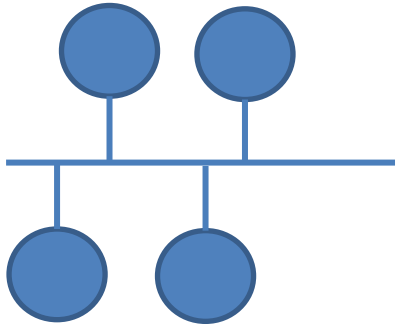
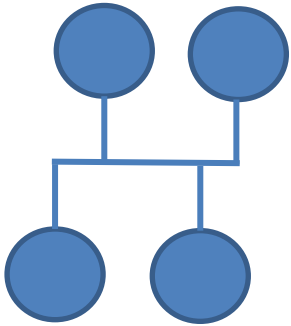
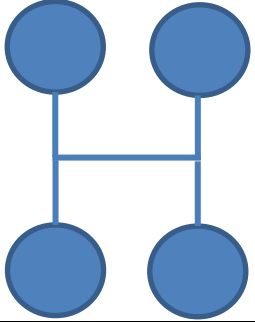
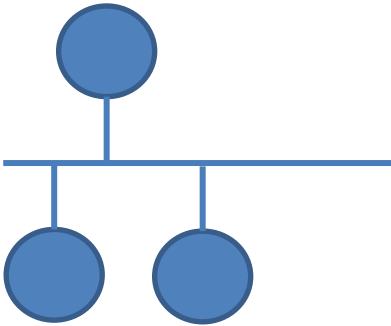
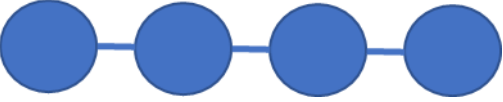
11	1	<p>2 marks for AO2 (apply)</p> <p>The diagram should clearly show that:</p> <ul style="list-style-type: none">• There are four or more computers/laptops/desktop computers in the diagram;• Each computer is connected only to a central hub/switch; <p>I. other connected devices. I. representation/symbol used for computer or hub/switch.</p> <p>Examples:</p> <table border="1" data-bbox="260 696 1342 1503"><tr><td data-bbox="260 696 799 1115"><p>2 marks</p></td><td data-bbox="799 696 1342 1115"><p>2 marks</p></td></tr><tr><td data-bbox="260 1115 799 1503"><p>1 mark</p></td><td data-bbox="799 1115 1342 1503"></td></tr></table>	<p>2 marks</p> 	<p>2 marks</p> 	<p>1 mark</p> 		2
<p>2 marks</p> 	<p>2 marks</p> 						
<p>1 mark</p> 							

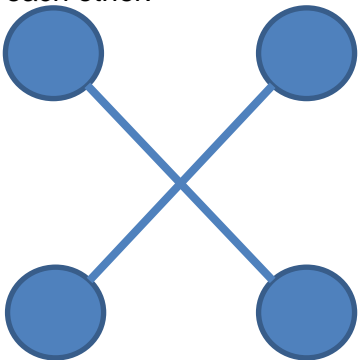
11	2	<p>2 marks for AO2 (apply)</p> <p>The diagram should clearly show that:</p> <ul style="list-style-type: none"> • There is a central bus • All computers are individually connected to a single central bus • There are four or more computers/laptops/desktop computers <p>2 marks for all three points, 1 mark for one or two of the three points.</p> <p>I. Representation/symbol used for computer. I. Other connected devices.</p> <p>Example answers:</p> <table border="1" data-bbox="260 797 1334 2033"> <tr> <td data-bbox="260 797 777 1189"> <p>2 marks</p>  </td> <td data-bbox="777 797 1334 1189"> <p>2 marks</p>  </td> </tr> <tr> <td data-bbox="260 1189 777 1543"> <p>2 marks</p>  </td> <td data-bbox="777 1189 1334 1543"></td> </tr> <tr> <td data-bbox="260 1543 777 2033"> <p>1 mark – central bus and three computers connected</p>  </td> <td data-bbox="777 1543 1334 2033"> <p>1 mark – four computers, no bus indicated, connections are between machines and not onto a bus.</p>  </td> </tr> </table>	<p>2 marks</p> 	<p>2 marks</p> 	<p>2 marks</p> 		<p>1 mark – central bus and three computers connected</p> 	<p>1 mark – four computers, no bus indicated, connections are between machines and not onto a bus.</p> 	2
<p>2 marks</p> 	<p>2 marks</p> 								
<p>2 marks</p> 									
<p>1 mark – central bus and three computers connected</p> 	<p>1 mark – four computers, no bus indicated, connections are between machines and not onto a bus.</p> 								

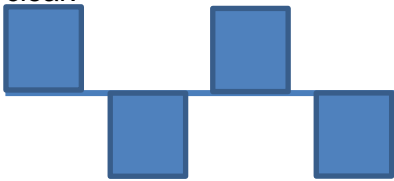
		<p>1 mark – four computers, no bus, computers connected directly to each other.</p> 	<p>R: insufficient computers and not clear that a bus is present.</p> 	
		<p>1 mark – four computers, bus is not clear.</p> 		

11	3	<p>2 marks for AO1 (understanding)</p> <p>1 mark for each point to a maximum of 2 marks.</p> <ul style="list-style-type: none"> • Less likely to experience transmission errors/data traffic problems (contention issues); • Faster transmission of data; • A faulty connection only disables one computer (unless it's the hub/switch); • Fewer/no collisions (if a switch is used rather than a hub); • Better security (potentially as data is not broadcast to all machines if a switch is used); <p>R. Easy to connect other devices.</p>	2
----	---	---	---

11	4	<p>1 mark for AO1 (understanding)</p> <p>1 mark for any valid point.</p> <ul style="list-style-type: none"> • It is more expensive to install (more cable required, more hardware needed); • It is harder to install (it requires more cable); • Switch/ hub/central device may fail (breaking the entire network); 	1
----	---	---	---

11	5	9 marks for AO1 (understanding)	9															
		<table border="1"> <thead> <tr> <th style="text-align: center;">Level</th> <th style="text-align: center;">Marks</th> <th style="text-align: left;">Description</th> </tr> </thead> <tbody> <tr> <td style="text-align: center;">3</td> <td style="text-align: center;">7–9</td> <td> <p>The student has explained all or discussed some risks and benefits of using computer networks. A clear understanding of both is shown.</p> <p>Technical language is used accurately throughout the response.</p> </td> </tr> <tr> <td style="text-align: center;">2</td> <td style="text-align: center;">4–6</td> <td> <p>The student has described or explained some risks and benefits. Some understanding is shown of both or a good understanding is shown of one.</p> <p>Some technical language is mostly used accurately in the response.</p> </td> </tr> <tr> <td style="text-align: center;">1</td> <td style="text-align: center;">1–3</td> <td> <p>The student has stated or described some risks or benefits. Little understanding is shown of either.</p> <p>Technical language is never/rarely used and where present may lack accuracy.</p> </td> </tr> <tr> <td style="text-align: center;">0</td> <td style="text-align: center;">0</td> <td>Nothing worthy of credit.</td> </tr> </tbody> </table>	Level	Marks	Description	3	7–9	<p>The student has explained all or discussed some risks and benefits of using computer networks. A clear understanding of both is shown.</p> <p>Technical language is used accurately throughout the response.</p>	2	4–6	<p>The student has described or explained some risks and benefits. Some understanding is shown of both or a good understanding is shown of one.</p> <p>Some technical language is mostly used accurately in the response.</p>	1	1–3	<p>The student has stated or described some risks or benefits. Little understanding is shown of either.</p> <p>Technical language is never/rarely used and where present may lack accuracy.</p>	0	0	Nothing worthy of credit.	
Level	Marks	Description																
3	7–9	<p>The student has explained all or discussed some risks and benefits of using computer networks. A clear understanding of both is shown.</p> <p>Technical language is used accurately throughout the response.</p>																
2	4–6	<p>The student has described or explained some risks and benefits. Some understanding is shown of both or a good understanding is shown of one.</p> <p>Some technical language is mostly used accurately in the response.</p>																
1	1–3	<p>The student has stated or described some risks or benefits. Little understanding is shown of either.</p> <p>Technical language is never/rarely used and where present may lack accuracy.</p>																
0	0	Nothing worthy of credit.																
		<p>Sample guidance</p> <p>Benefits:</p> <ul style="list-style-type: none"> • Sharing of resources such as printers, storage space • Managed/central backing up of data • Central installation and management of software by network admin • Monitoring of users and network activity centrally by network admin • Hot desking/users can login to any machine • Ability to use communication tools between computers • Centrally managed access rights • Rapid data sharing • Allows decentralised/home working <p>Risks:</p> <ul style="list-style-type: none"> • Security of data – requires correct settings or anyone can see restricted data • Spreading of malware • Cost of infrastructure • Cost of network admin required to run network • Dependency on network hardware 																

11	6	<p>2 marks for AO1 (recall)</p> <p>A set of rules; that allow devices/networks to communicate/transfer data;</p>	2
----	---	---	---

11	7	<p>2 marks for AO1 (recall)</p> <p>C IMAP; D SMTP;</p> <p>If more than two lozenges shaded then marks are not awarded.</p>	2
----	---	--	---

12	1	<p>2 marks for AO1 (understanding)</p> <p>Max 2 marks for one of the points below well explained OR two points stated from the list below.</p> <ul style="list-style-type: none"> • It prevents unauthorised access into the network (by checking IP/MAC address/packet content); • It prevents unauthorised transmissions from inside the network to external locations; • It monitors network traffic; • It makes sure that only the right/authorised traffic is allowed; • It opens/closes ports as necessary; <p>R. Prevents unauthorised users accessing network. R. Prevents access to unauthorised websites.</p>	2
----	---	---	---

12	2	<p>3 marks for AO1 (understanding) and 3 marks for AO2 (apply)</p> <p>2 marks per method, 1 mark for stating the method, 1 mark for an explanation.</p> <ul style="list-style-type: none"> • Passwords; a set of characters that is only known by the person who is being authenticated// a set of characters that is entered and compared against a database/recorded version; • Biometric; measures such as fingerprint, facial, iris, voice-print that use the user's physical features to prove who they are; • Email confirmation; sends an email which requires a valid email address and for the recipient to respond to prove the email and hence user is valid; <p>A. Other methods that are not in the specification that are appropriate should also be awarded marks. Examples such as 2 Factor Authentication (2FA), Authenticator Apps, security questions.</p>	6
----	---	--	---

12	3	<p>4 marks for AO1 (understanding)</p> <p>Maximum of 3 marks if only 1 type of testing.</p> <p>Black box testing:</p> <ul style="list-style-type: none"> • the tester does not know how the system operates; • the tester is acting as an external hacker; • requires a lot of investigation and guessing/brute-force to find issues; • may not test all of the system especially if you do not know it's full functionality; • you are trying to discover and exploit the weak spots in the system; <p>White box testing:</p> <ul style="list-style-type: none"> • the operation of the system is known; • the tester is simulating a malicious insider; • can be targeted to test specific vulnerabilities; • you know exactly what you are trying to test; • because you know what you are testing you should be able to test all possible scenarios; <p>R. Any direct opposites. Statements such as “Black box has no knowledge of how the system operates. White box has knowledge of how the system operates.” would be awarded only one mark.</p>	4
----	---	--	---

13	<p>2 marks for AO1 (recall)</p> <p>2 marks for all four correct ;; 1 mark for any two correct ;</p> <table border="1" style="width: 100%; border-collapse: collapse;"> <thead> <tr> <th style="text-align: left;">Definition</th> <th style="text-align: center;">Letter</th> </tr> </thead> <tbody> <tr> <td>Addresses data for transmission</td> <td style="text-align: center;">C</td> </tr> <tr> <td>Sets up the communication between the two hosts</td> <td style="text-align: center;">B</td> </tr> <tr> <td>Where the network hardware is located</td> <td style="text-align: center;">D</td> </tr> <tr> <td>Where the user software, such as web browsers or email programs, operates</td> <td style="text-align: center;">A</td> </tr> </tbody> </table> <p>R. Duplicate answers.</p>	Definition	Letter	Addresses data for transmission	C	Sets up the communication between the two hosts	B	Where the network hardware is located	D	Where the user software, such as web browsers or email programs, operates	A	2
Definition	Letter											
Addresses data for transmission	C											
Sets up the communication between the two hosts	B											
Where the network hardware is located	D											
Where the user software, such as web browsers or email programs, operates	A											

14	<p>3 marks for AO1 (recall), 3 marks for AO1 (understanding)</p> <p>1 mark each for stating, 1 mark each for describing.</p> <ul style="list-style-type: none"> • Trojan (horse); a program which misleads the user into thinking it is another piece of software which, when run, executes another program; • Spyware; a program which records data such as usernames and passwords on a host system and forwards the information to a third party; • Adware; code embedded or attached to program files which will persistently show adverts (that attempt to generate revenue); • Worm; code which will run autonomously and replicates itself on a host system; • Ransomware; a program that encrypts user's data to make it unreadable until they pay for the key; • Remote Access Tool (RAT); allows access to control and monitor a computer from a remote network location; • Rootkit; malware that has managed to gain 'root' admin privileges; • Bots/Zombies; a program installed on a computer that performs a job for the remote owner of the bot/zombie such as sending spam or sending web requests to perform a DOS or attacking a computer system; • Scareware; malware that tells you something is wrong with your system in an attempt to get you to make a purchase; • Keylogger; a program that monitors/records a user's keystrokes in order to steal passwords/confidential details; <p>R. Specific named examples on their own, eg "Wannacry" would receive no marks, "Ransomware such as Wannacry" would receive 1 mark.</p> <p>R. References to 'virus' as this is the example in the question.</p>	6
----	--	---

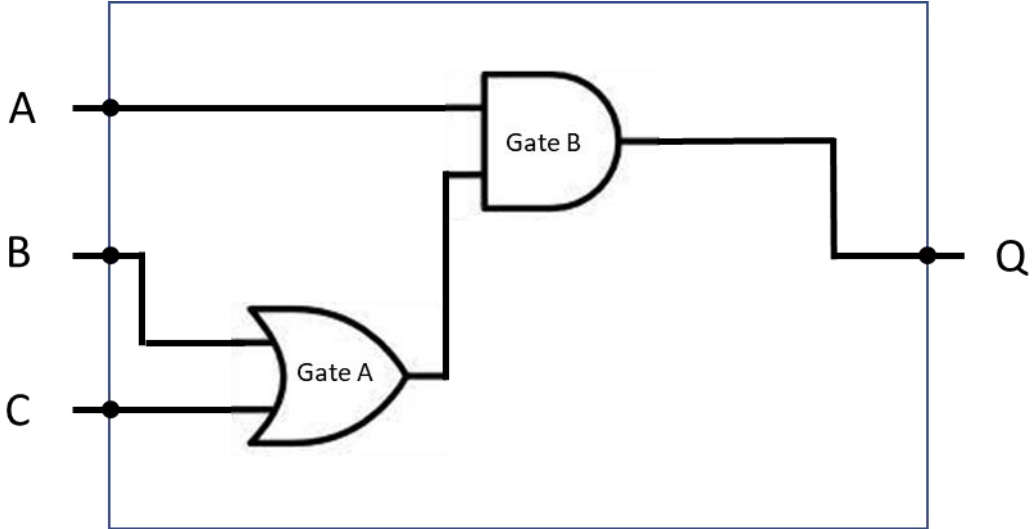
15	<p data-bbox="228 264 564 297">3 marks for AO2 (apply)</p>  <p data-bbox="277 909 1318 1093"><ul style="list-style-type: none">• OR Gate, with correct symbol used, with TWO inputs from B and C;• AND Gate, with correct symbol used, with TWO inputs from A and Gate A (even if Gate A is an incorrect gate);• Output from Gate B is the only connection to Q (even if Gate B is an incorrect gate);</p>	3
----	---	---

16	4 marks for AO1 (understanding) 8 marks for AO2 (apply)	12
Level	Description	Mark range
4	<p>Evidence of a clear understanding is shown through discussion of the devices' properties.</p> <p>Comparisons are well supported by valid technical explanations for the advantages and disadvantages.</p> <p>Explanations are clear and accurate, using correct and detailed technical language throughout.</p>	10–12
3	<p>Evidence of a more developed understanding is shown through comparisons of the devices' properties.</p> <p>Comparisons are supported by explanations that give valid technical reasons for the advantages and/or disadvantages.</p> <p>Technical language is used accurately in most cases.</p>	7–9
2	<p>Evidence of some understanding is shown by making brief comparisons of the devices' properties.</p> <p>Comparisons are supported by simple descriptions of the advantages and/or disadvantages.</p> <p>There is some use of technical language although its use is sometimes inaccurate.</p>	4–6
1	<p>Evidence is shown of limited understanding through a simple identification of which device's properties are better or worse than the other.</p> <p>Limited supporting statements are provided.</p> <p>There is no use of technical language, or if there is it is used inaccurately.</p>	1–3
No creditworthy material		0
Guidance:		
There are 5 different properties that can be compared between the devices: cores; clock speed; cache; RAM; HDD/SSD.		

Possible comparisons	Device A	Device B
Core	Quad (4) core <ul style="list-style-type: none"> • More cores than B. • Can process more commands in same time than dual core. 	Dual (2) core <ul style="list-style-type: none"> • Less cores than A. • Can process fewer commands in same time than quad core.
Clock Speed	1.6 GHz CPU <ul style="list-style-type: none"> • Lower clock speed than B. • Would process fewer instructions per second than B if it had the same number of cores. • Combined with the quad core processor this equates to raw power of 6.4 billion instruction per sec – theoretically worse than B. • Slower processor so more energy efficient. 	3.9 GHz CPU <ul style="list-style-type: none"> • Higher clock speed than A. • Would process more instructions per second than A if it had the same number of cores. • Combined with the dual core processor this equates to raw power of 7.8 billion instructions per sec – so theoretically better than A. • Faster speed means more power consumption/less efficient. • So may run hotter.
Cache	8 MB cache <ul style="list-style-type: none"> • More cache than B. • Theoretically CPU A will have to wait less time to get instructions. • Despite less raw speed this may mean A is overall faster than B. 	2 MB cache <ul style="list-style-type: none"> • Less cache than A. • Because it has less cache than A there might be bottlenecks. This might negate B's overall better raw speed than A.
RAM	16 GB RAM <ul style="list-style-type: none"> • More RAM than B. • Potential boost to A as more programs and data will be held in memory, reducing time to read from secondary storage. 	4 GB RAM <ul style="list-style-type: none"> • Less RAM than A. • More likely to require use of virtual memory. • Increased access of secondary storage may be balanced by use of faster SSD.
Secondary Storage	2 TB Hard Disk Drive (HDD) <ul style="list-style-type: none"> • More storage than B. • Slower access than SSD. • Less resilient, as mechanical. • May be more suitable for large media files. 	250 GB Solid State Drive (SSD) <ul style="list-style-type: none"> • Much less storage than A. • SSDs more resilient. • SSDs faster. • because uses flash memory. • Less useful for storing large files, eg media. • More energy efficient as no motor.
Overall comparison	Overall, not much difference in processing speeds but A more suitable for non-mobile device processing lots of media and B fairly powerful mobile computer but with limited storage space.	